



LAYING INSTRUCTIONS

REV._09/19



STAIRS CLADDING WITH NOVOWOOD SYSTEM

LIST OF MATERIALS TO BE USED



**Solid profile staves 145x22x2200mm
cod. 145S22**



Aluminium subconstruction framework joists

**AVERAGE USE PER m²
3,50 m/m²**

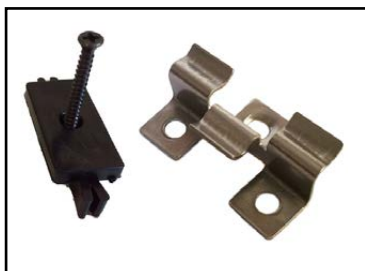

**Nylon or steel clips
cod. CLPN5 / CLPX3**



**Starter clips
cod. IF**



Steel flat bracket
*possibility to use a unique element
angular + flat bracket



Steel angular L-shaped bracket
*possibility to use a unique element
angular + flat bracket

IMPORTANT NOTES

INFORMATION ON OVERLOAD

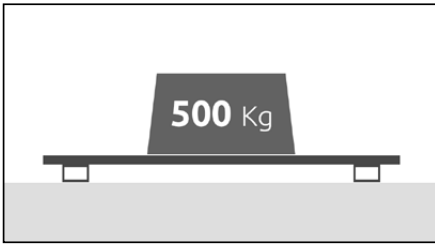

Floors constructed with Novowood staves, both filled and hollow core, combined with joists and fixed with Novowood Clips, laid with joists with a spacing of 35 cm, are designed to support accidental overloads with resistance to distributed loads equal to 500 kg/m². In case of big loads and in all the public spaces, it is necessary to lay the joists with a maximum spacing of 30 cm.

CORRECT USE OF THE MATERIAL

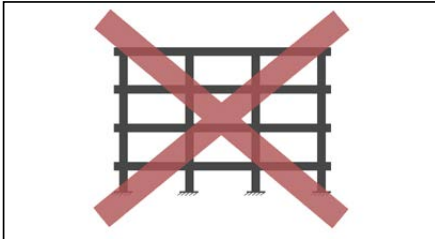

Novowood products are coating materials that, despite their mechanical strength characteristics, must always be laid on a supporting subconstruction framework of a suitable size.

THERMAL EXPANSION

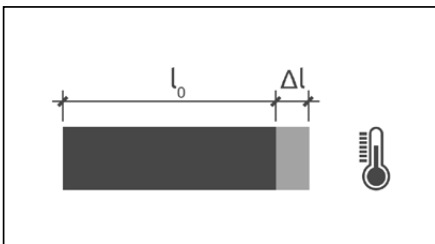

Wood plastic composite is subject to slight thermal expansion due to the presence of a small amount of HDPE plastic in its mix. The expansion index defined in the data sheet is equal to **0.04 mm/m/°C**. It is therefore recommended to calculate the grouting between the staves heads according to external temperatures during laying and to the annual thermal variation forecast.

VENTILATION AND AIRSPACE

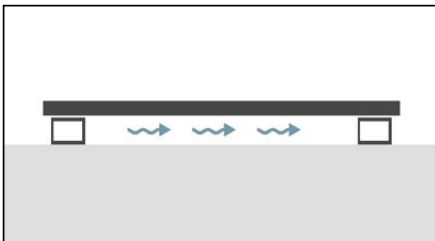

It is essential to ALWAYS leave an airspace between the staves and the supporting surface to allow ventilation. In addition to the use of a proper subconstruction framework it is necessary to avoid interferences between the airspace and edges or barriers that block a proper ventilation under the profiles.

FIXINGS

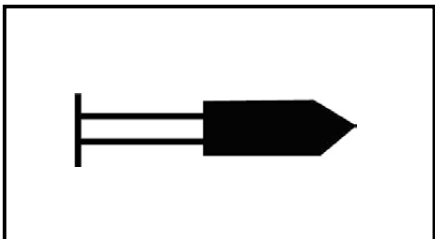

It is necessary to evaluate the fixing system which is more suitable according to the typology of substrate and the loads.

HUE VARIATIONS OF DIFFERENT LOTS

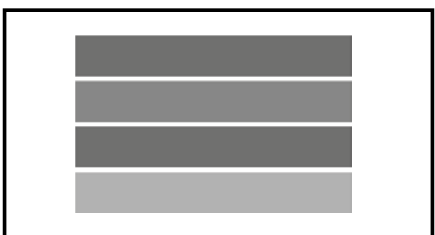

Novowood is a wood plastic composite produced by extrusion, therefore it is possible to have little hue variations between different lots produced. It is advisable to lay the material picking up staves from different pallets.

LAYING OF THE STAVES ON STAIRS STEP BY STEP GUIDE

1 CUTTING OF STAVES

Measure the width of stairs and later cut to the proper length the necessary staves, considering the thermal expansion of the material.



2 CLIPS INSERTION

Insert between the 2 staves of the tread a number of clips in the same amount of the joists, to be fixed afterwards.

The number of joists is established according to operating loads, considering the indications in the material datasheet.

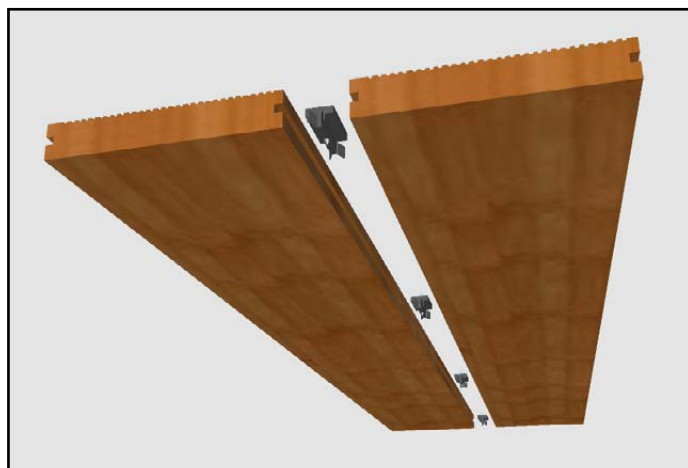

3 FIXING THE STAVES OF THE TREAD

Unite the 2 staves of the tread with metal brackets and fixings of a proper length.



ATTENTION

Pay attention to the fixing position of the brackets which must not interfere with the joists on which the staves will lay.

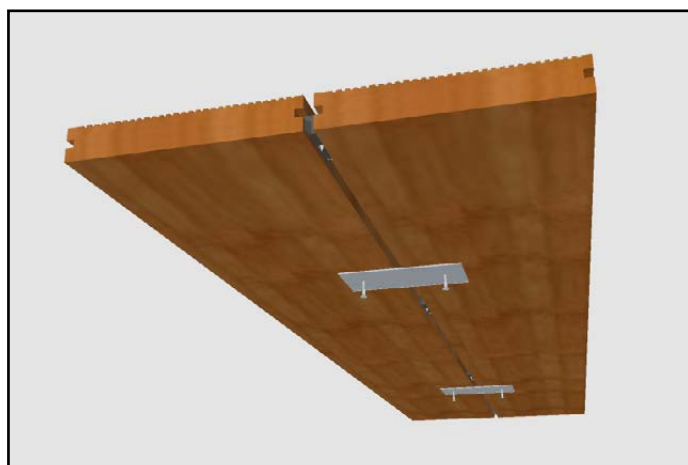

4 FIXING THE STAVE OF THE RISE WITH THE TREAD

Unite the stave of the rise with the staves of the tread, previously assembled, with steel angular L-shaped brackets.

It is possible to trim the external stave of the tread in order to obtain a smooth finishing.

N.B. It is advised to place the flat and angular brackets in a contiguous position, in order to not interfere with the subsequent fixing on the joists.

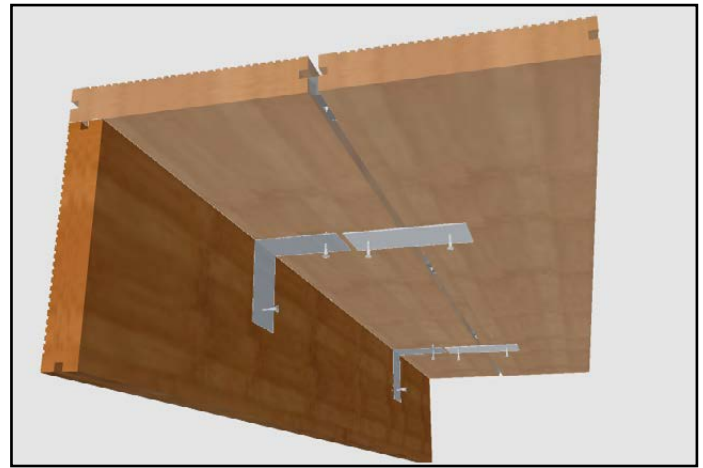

ATTENTION

The stave of the rise must be fixed under the stave of the tread, as shown in the detail, in order to avoid excessive mechanical stress on the vertical stave of the rise.

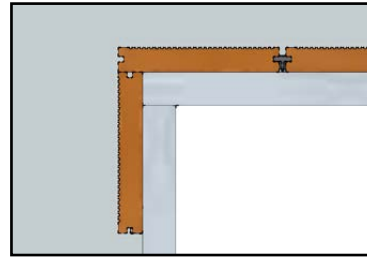

5 FIXING STARTER CLIPS

Fix the starter clip to the joist of the rise in order to define the alignment of start/support of the previously assembled element.



ATTENTION

The fixing position must be 145 mm (width of the stave) from the inferior edge of the rise.

You should make tests positioning the stave before definitively fixing the clip.

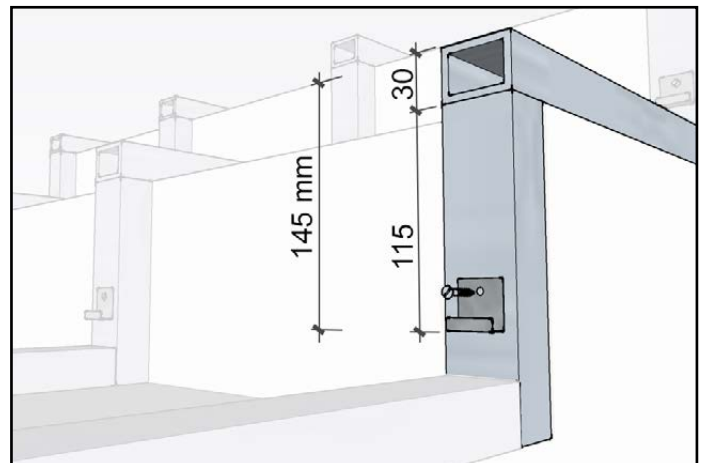

6 DIMENSIONING OF THE SUBCONSTRUCTION FRAMEWORK JOISTS

In order to calculate the correct length of the joists you will have to measure the width of the tread and the height of the rise and subtract 2/3 mm in order to allow the thermal expansion of the material.

Example:

joist of the tread = width of the tread - 2 mm.

$$295 \text{ mm}_{\text{tread}} - 2 \text{ mm}_{\text{expansion}} = 293 \text{ mm}$$

joist of the rise = height of the rise - 2 mm.

$$168 \text{ mm}_{\text{rise}} - 2 \text{ mm}_{\text{expansion}} = 166 \text{ mm}$$

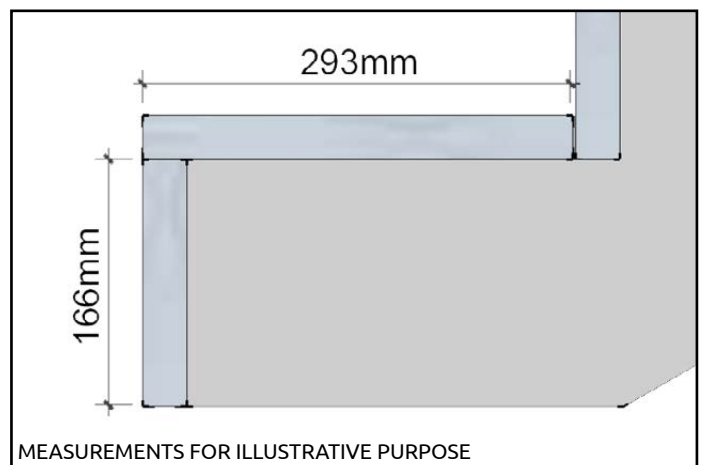

7 POSITIONING OF SUBCONSTRUCTION FRAMEWORK JOISTS

Place the joists on the steps with an equal distance between each other, respecting the project regulations or the indications in the datasheet.

The maximum suggested distance between 2 joists is 350 mm. It is advised to reduce the distance in case of highly crowded spaces.

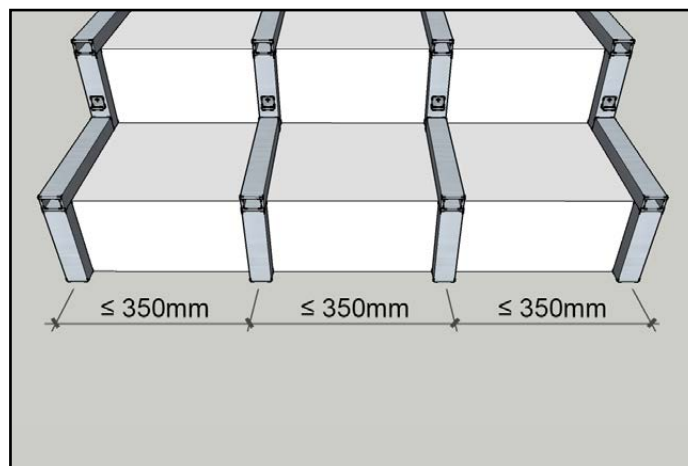

8 FIXING OF THE SUBCONSTRUCTION FRAMEWORK JOISTS

Fixing the joists to the substrate **is necessary** in order to guarantee an additional solidity to the structure. The joists can be fixed to the substrate, for example in concrete, with L brackets, making fixings that allow the expansion, or with percussion anchors suitable for the substrate.

The designer or the installer must decide the positioning and the number of fixings, according to the peculiarity of the project.

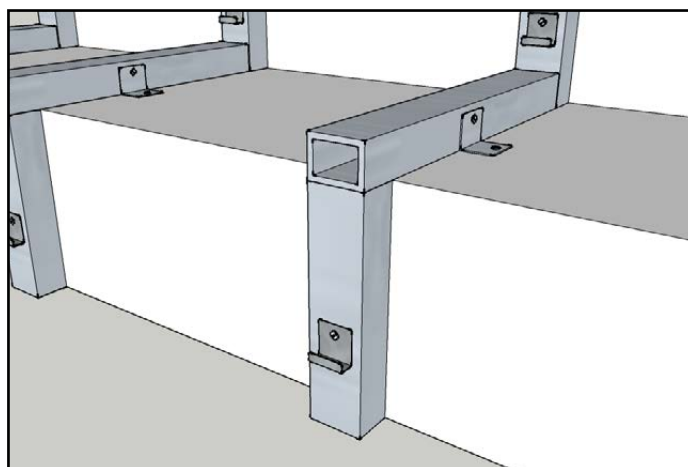

9 STEP POSITIONING

Position the preassembled step on the joists, getting it in position from above until connecting it with the starter clips.

Make sure that the preassembled step lays correctly on all the joists in order to allow a stable fixing.

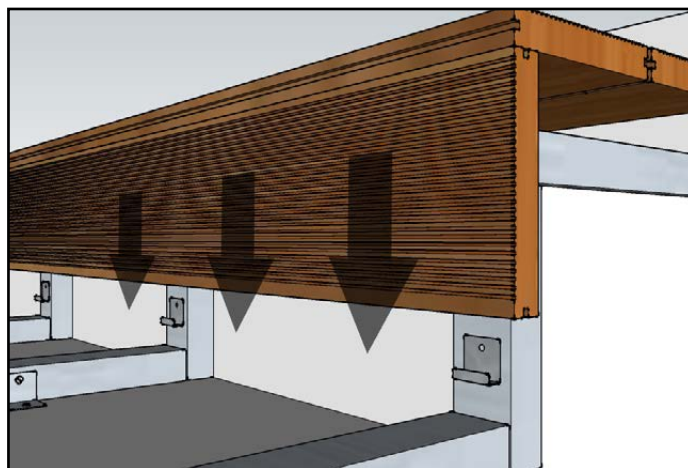

10 FIXING THE STEP TO THE JOISTS

Place the clips, previously left loose among the staves, in line with the joists and make the definitive fixing.



USE TYPOLOGIES

Novowood products can be used to cover different kinds of staircases. Every system must always be approved by a qualified professional and adapted to the different peculiarities and needs.

Novowood products can be used to cover stairs in brickwork and concrete.

In case of stairs with metal structure, the elements can be preassembled in frames/stairs for a quicker installation.

INFORMATION ON NOVOWOOD'S LIABILITY

The distances to be observed and the method of installation can be evaluated according to the needs of the client and the contractor during laying. The company does not assume any liability for negligence in the installation of NOVOWOOD products.

Please check possible updates of the manuals on the website www.novowood.it in the download section.

NOTES



NOVOWOOD
HEADQUARTER
Via E. da Rotterdam, 29
44122 Ferrara (FE)

+39 0532 732737
info@novowood.it

www.novowood.it